

# Messerschmitt Bf.109 G-2

*"GUSTAV"*



By Chuck

# TABLE OF CONTENTS

- PART I: THE AIRCRAFT
- PART II: THE CONTROLS
- PART III: TAKEOFF
- PART IV: LANDING
- PART V: ENGINE MANAGEMENT
- PART VI: AIRCRAFT PERFORMANCE

	(Unit)	LaGG-3	Yak-1	La-5	Il-2	Pe-2	Bf.109F4	Bf.109G2	Fw190A3	Ju-87	He-111
--	--------	--------	-------	------	------	------	----------	----------	---------	-------	--------

### TEMPERATURES

<b>Water Rad Min</b>	Deg C	80	80	-	80	40	40	40	-	60	40
<b>Max</b>		100	100		110	100	100	100		100-110	95
<b>Oil Rad (OUTBOUND) Min</b>	Deg C	40	40	55	70	-	40	40	40	30	35
<b>Max</b>		100	100	75	115		80	80	110	105	95
<b>Oil Rad (INBOUND) Min</b>	Deg C	-	-	-	40	-	-	-	-	-	-
<b>Max</b>					80						
<b>Cylinder Head Temp Min</b>	Deg C	-	-	120	-	-	-	-	-	-	-
<b>Max</b>				200							

### ENGINE SETTINGS

<b>Takeoff RPM</b>	RPM	2700	2700	2400	2200	2700	2600	2500	2500	2500	2400
<b>Takeoff Manifold Pressure</b>	RU: mm Hg GER: ATA	1050	1050	1150	1150	1050	1.3	1.3	1.3	1.3	1.35
<b>Climb RPM</b>	RPM	2600	2650	2300	2050	2600	2600 30 min	2500	2400	2450 30 min	2300 30 min
<b>Climb Manifold Pressure</b>	RU: mm Hg GER: ATA	1020	1050	1150	1050	1050	1.3 30 min	1.3	1.3	1.25 30 min	1.15 30 min
<b>Normal Operation/Cruise RPM</b>	RPM	1700	1850	2300	1850	2200	2200	1900	2200	2100	2200
<b>Normal Operation/Cruise Manifold Pressure</b>	RU: mm Hg GER: ATA	1020	850	900	850	1020	1.0	1.0	1.1	1.2	1.10
<b>Combat RPM</b>	RPM	2650	2650	2400	2050	2600	2600	2500	2400	2250	2300
<b>Combat Manifold Pressure</b>	RU: mm Hg GER: ATA	1050	1050	1150	1050	1050	1.3	1.3	1.32	1.2	1.15
<b>Emergency Power/ Boost RPM @ km</b>	RPM	2700	2700	2400 10 min max	2200	2700	2700 1 min max	2500	2600 7-8 min max	2600 1 min max	2400 1 min max
<b>Emergency Power / Boost Manifold Pressure @ 1 km</b>	RU: mm Hg GER: ATA	1050	1050	1150 10 min max	1150	1050	1.42 1 min max	1.3	1.42 7-8 min Max	1.4 1 min max	1.35 1 min max
<b>Supercharger Stage 1 Operation Altitude</b>	m	0 2000	0 2500	0 2000	-	0 2000	-	-	-	Auto/man modes	Auto/man modes
<b>Supercharger Stage 2 Operation Altitude</b>	m	2000+	2500+	2000+	-	2000+	-	-	-	Auto/man modes	Auto/man modes
<b>*Landing Approach RPM</b>	RPM	2600	2200	2400	1800	2700	1500	1500	-	2000	2300
<b>*Landing Approach Manifold Pressure</b>	RU: mm Hg GER: ATA	As required	600	As required	600	As required	0.6	0.6	-	0.6	As required
<b>Notes</b>				Open Oil Radiator at all times	Close Oil radiator in combat	Flaps 30 on Takeoff & 15 on Landing			Lock tailwheel on takeoff	No Abrupt Throttling	Eng. very sensitive to ata/rpm

### AIRSPEEDS

<b>Takeoff – Rotation</b>	km/h	190	200	180	190	250	180	180	200	170	150
<b>Optimal Climb Speed</b>	km/h	270	260	250	250	240	280	280	270	230	N/A
<b>Landing – Approach</b>	km/h	200	180	200	200	200	180	180	190	190	200
<b>Landing – Touchdown</b>	km/h	170	150	170	150	160	160	160	150	150	140-150

## History



The Messerschmitt 109 was a German fighter aircraft designed by Willy Messerschmitt and Robert Lusser during the early to mid-1930s. It was one of the first truly modern fighters of the era, including such features as all-metal monocoque construction, a closed canopy, a retractable landing gear, and was powered by a liquid-cooled, inverted-V12 aero engine

The Bf 109 was the most produced fighter aircraft in history, with a total of 33,984 airframes produced from 1936 up to April 1945. Originally conceived as an interceptor, later models were developed to fulfill multiple tasks, serving as bomber escort, fighter-bomber, day-, night-, all-weather fighter, ground-attack aircraft, and as reconnaissance aircraft. Through constant development, the Bf 109 remained competitive with the latest Allied fighter aircraft until the end of the war.

The Bf 109 G-series was developed from the largely identical F-series airframe, although there were detail differences. Modifications included a reinforced wing structure, an internal bullet-proof windscreen, the use of heavier, welded framing for the cockpit transparencies, and additional light-alloy armour for the fuel tank.. The G-2, which started production in May 1942, lacked the cabin pressurization and GM-1 installation. Performance-wise it was identical to the G-1. The canopy reverted to one layer of glazing and incorporated the angled head armour used on the F-4, although several G-2 had the vertical type as fitted to the G-1.

# PART I: THE AIRCRAFT

## The Cockpit



# PART I: THE AIRCRAFT

## Left Side

Engine controls	Switch propellers pitch control mode: manual/auto	RSht+P	joy1_b25
Weapons controls			
Flight leader commands	Propellers: high pitch	RSht+Equals	joy1_b26
Pilot gestures	Propellers: low pitch	RSht+Minus	joy1_b27

**\* Prop Pitch can only be modified once MANUAL prop mode has been engaged.**

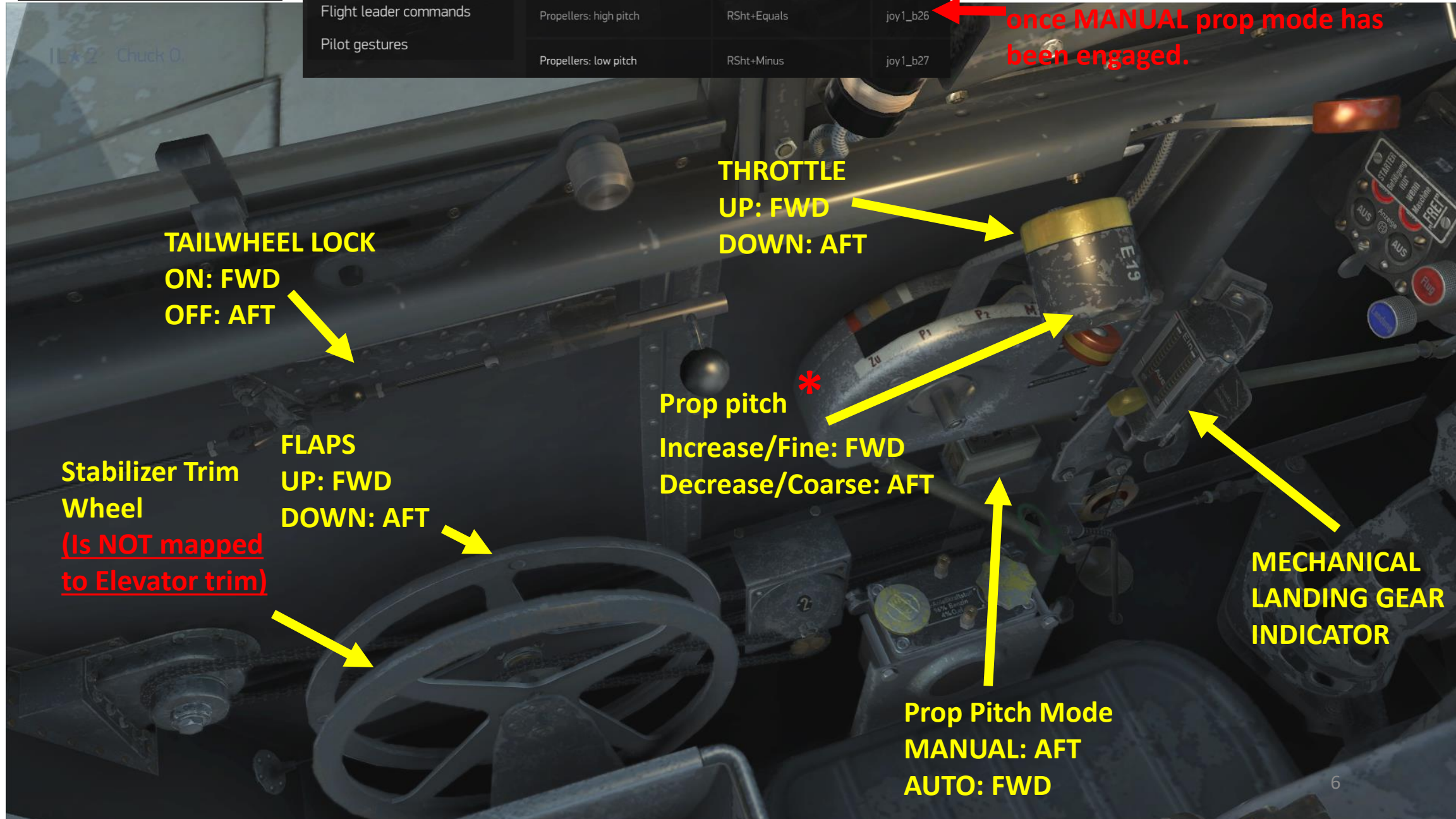

**TAILWHEEL LOCK**  
ON: FWD  
OFF: AFT

**THROTTLE**  
UP: FWD  
DOWN: AFT

**Stabilizer Trim Wheel**  
(Is NOT mapped to Elevator trim)

**FLAPS**  
UP: FWD  
DOWN: AFT

**Prop pitch** \*  
Increase/Fine: FWD  
Decrease/Coarse: AFT

**MECHANICAL LANDING GEAR INDICATOR**

**Prop Pitch Mode**  
MANUAL: AFT  
AUTO: FWD

# Right Side

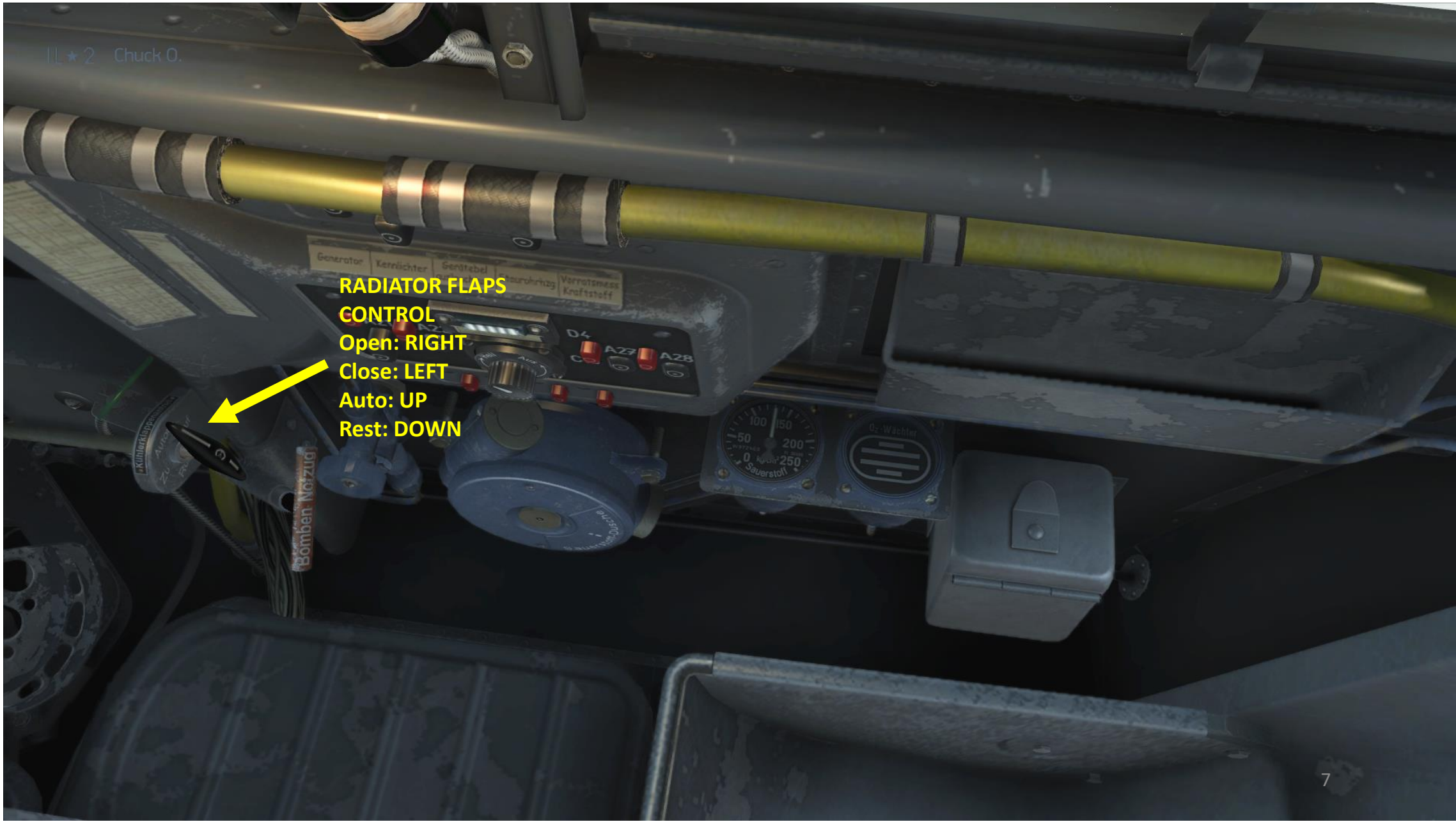

**RADIATOR FLAPS  
CONTROL**  
Open: RIGHT  
Close: LEFT  
Auto: UP  
Rest: DOWN

# PART I: THE AIRCRAFT

## Front Left

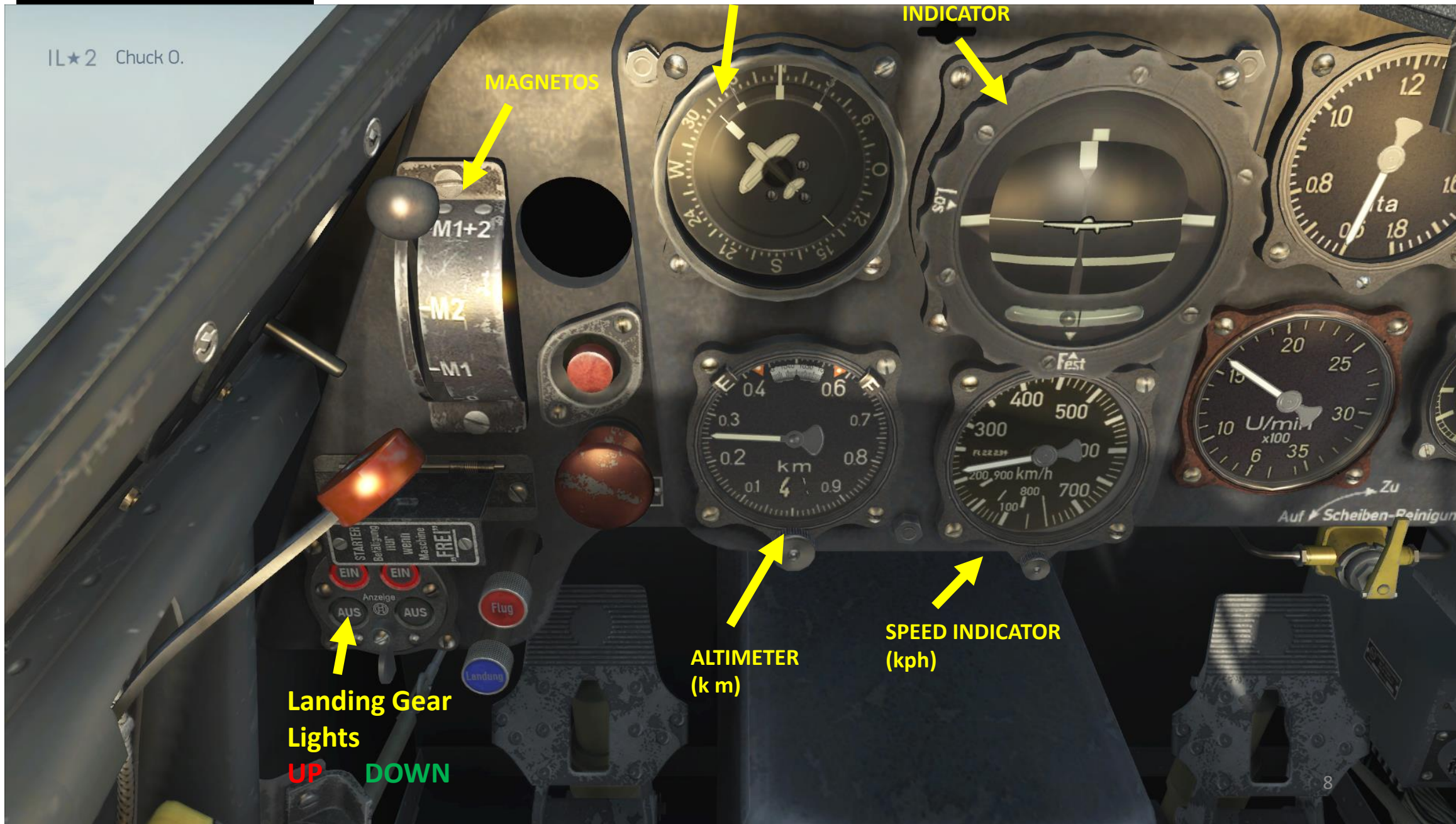



# PART I: THE AIRCRAFT

## Front Right

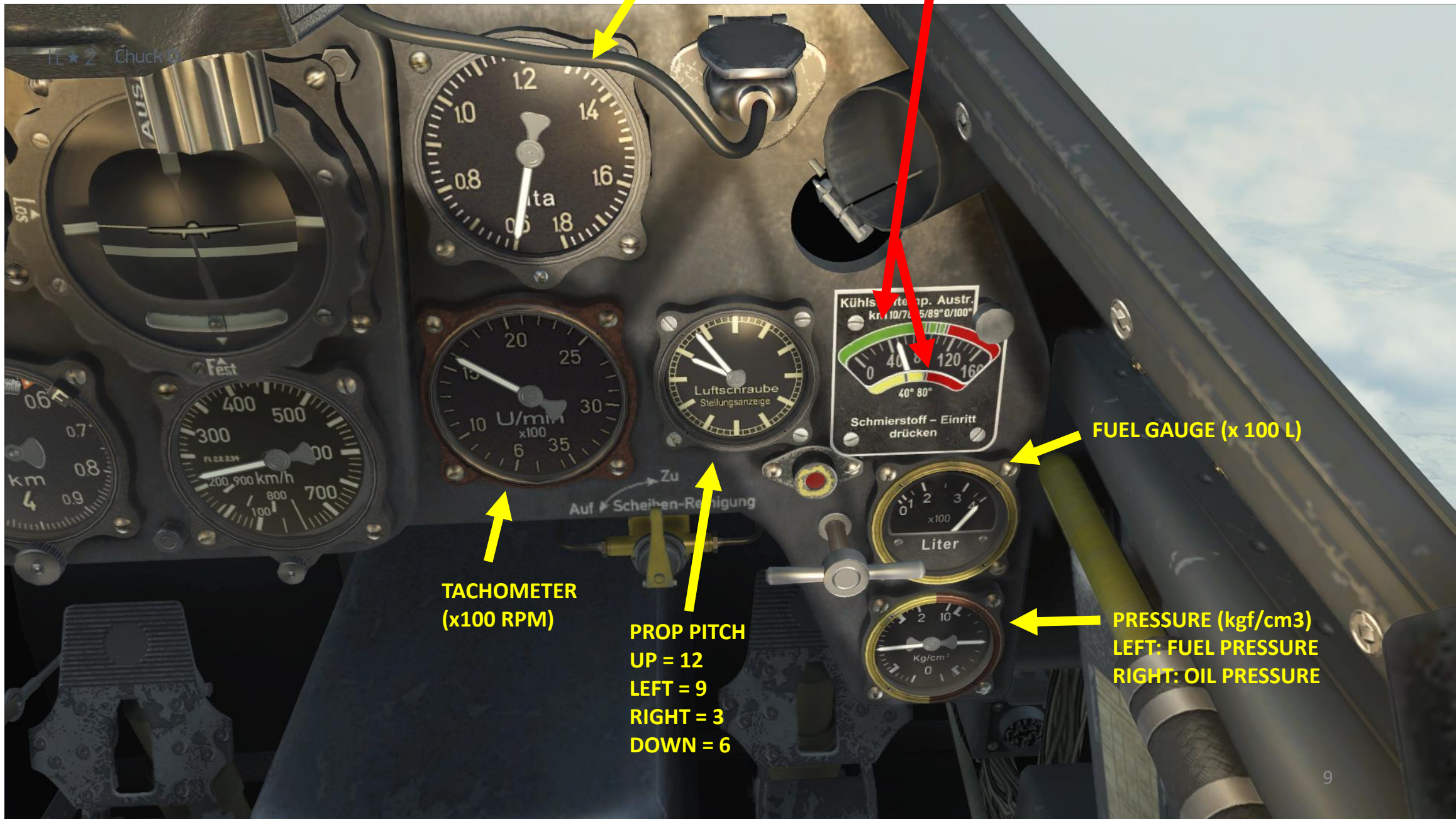

MANIFOLD PRESSURE  
ATA/atm

UPPER SCALE = COOLANT EXIT TEMPERATURE (DEG C)  
LOWER SCALE = OIL INTAKE TEMPERATURE (DEG C)

FUEL GAUGE (x 100 L)

TACHOMETER  
(x100 RPM)

PROP PITCH  
UP = 12  
LEFT = 9  
RIGHT = 3  
DOWN = 6

PRESSURE (kgf/cm<sup>3</sup>)  
LEFT: FUEL PRESSURE  
RIGHT: OIL PRESSURE

## Important key bindings

- The Bf 109 has automated radiator controls, so you do not need to think about them.
- You can control your prop pitch (which will affect your RPM), but only if you have engaged the MANUAL PROP PITCH mode. Make sure you have a key to it. Changing prop pitch manually is by no means necessary, but it can allow you to fine-tune your RPM setting and gain a marginal gain in performance as the AUTO mode already does that for you.
- Unlike in Russian aircraft, you do not control your mixture setting in the 109.
- In AUTO PROP PITCH mode, your RPM will be automatically adjusted in function of your ATA (Manifold Pressure) input.

Engine controls	Switch propellers pitch control mode: manual/auto	RSht+P	joy1_b25
Weapons controls			
Flight leader commands	Propellers: high pitch	RSht+Equals	joy1_b26
Pilot gestures	Propellers: low pitch	RSht+Minus	joy1_b27

# Important key bindings

- You can judge know approximately how much degrees of flaps are deployed by looking at “black marks” on the wings next to the junction between the trailing edge of the wing and the flap itself. One “notch” equals 10 degrees.

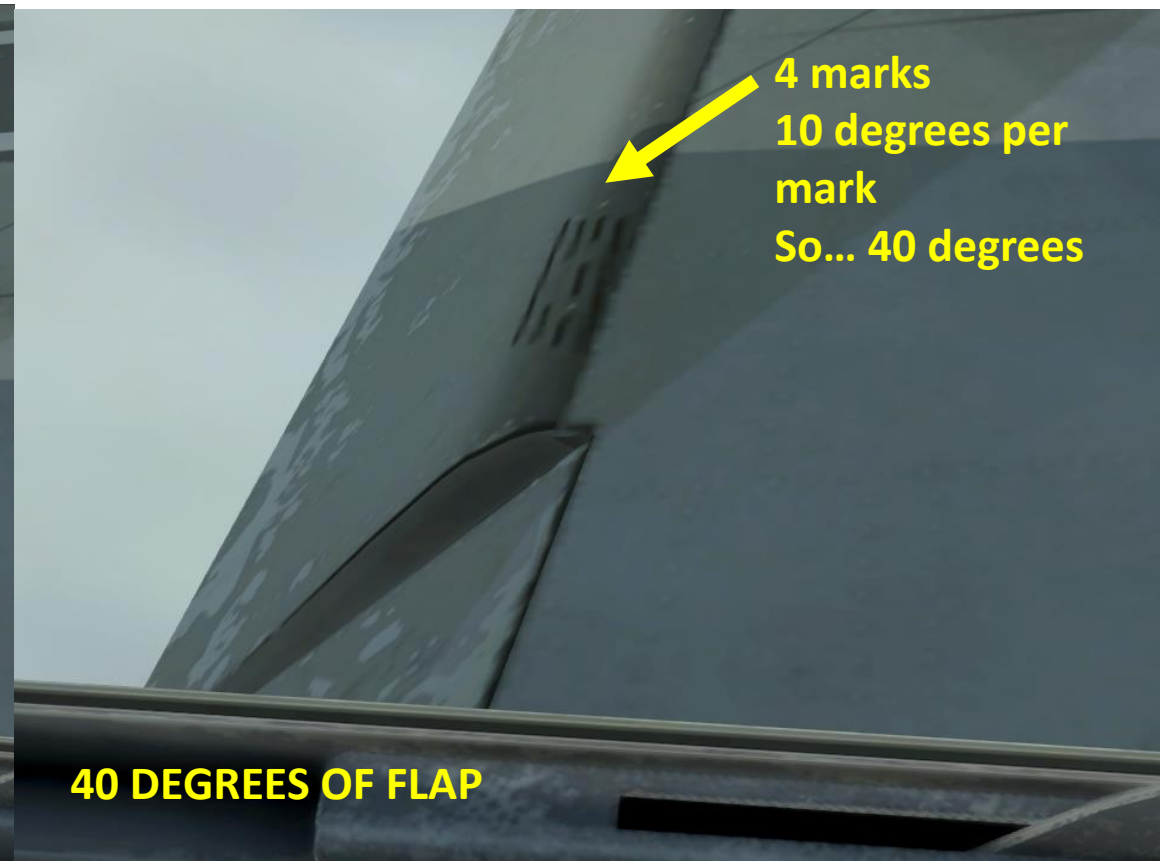
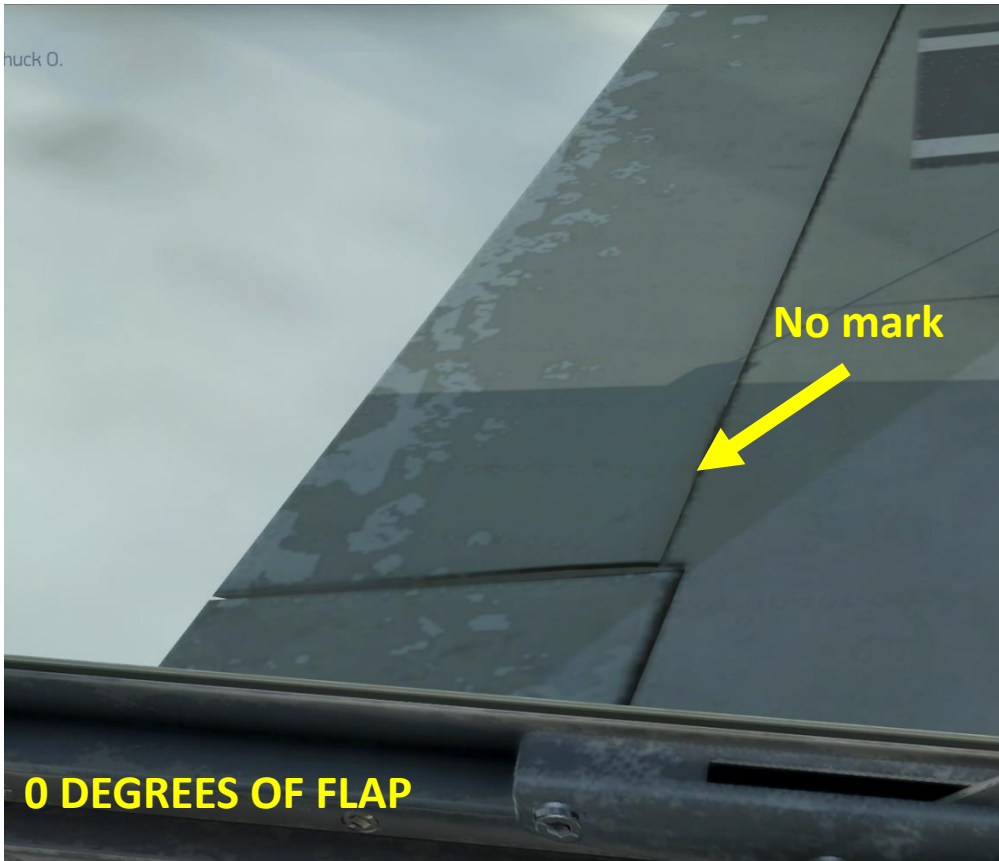

# PART II: THE CONTROLS

## Important key bindings

- The Bf.109, unlike most Russian planes, has a “toe brake” or “heel brake” system, which is linked to each individual wheel of your landing gear.
- In order to brake, you need to hold either your left or right wheel toe brake key to steer your aircraft.
- The main landing wheel brake system employs hydraulically actuated disc-type brakes. Each brake is operated by individual master brake cylinders located directly forward of the instrument panel. The brakes are selectively controlled by means of toe pedals incorporated into the rudder pedal assembly.

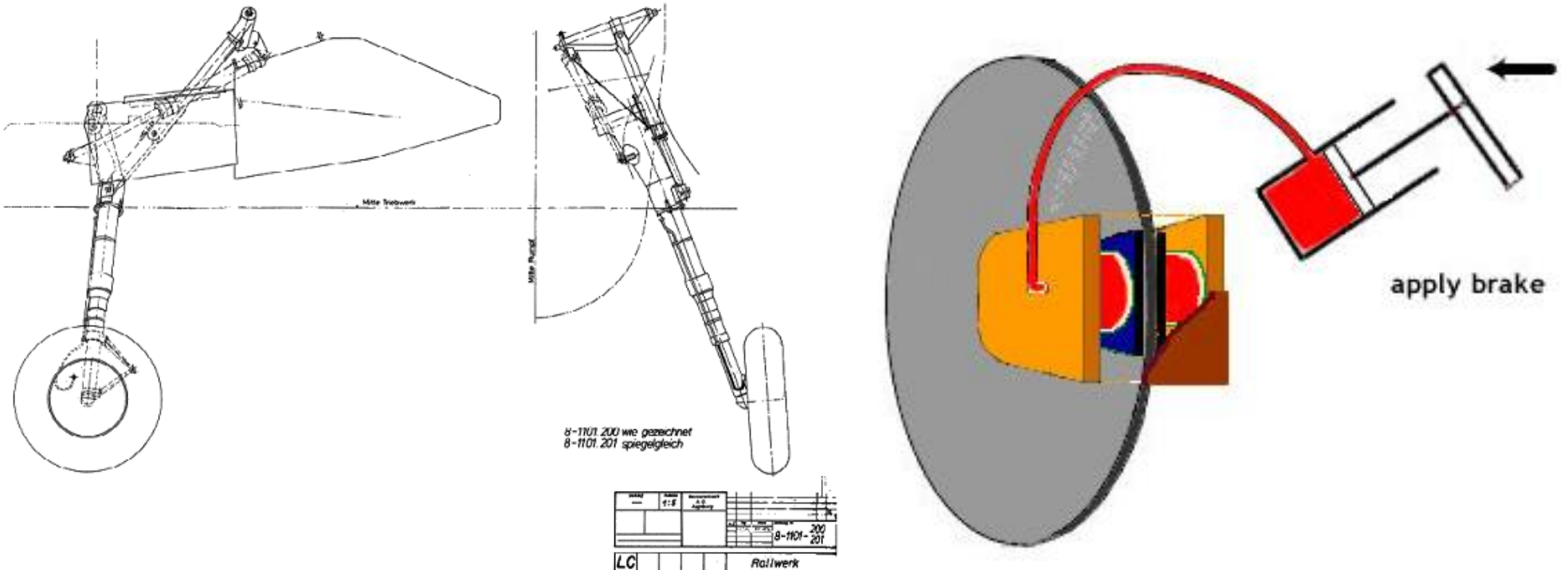

# PART III: TAKEOFF

- Taking off in the Bf.109 is straightforward if you follow these steps for a cold engine start.
  - 1) Crack your throttle about 15 %
  - 2) Set your prop pitch mode to “AUTO”
  - 3) Ignite (“E” key by default)!
  - 4) Wait for your oil temperature to reach 40 degrees C
  - 5) Taxi to the runway (unlock tailwheel, LShift+G by default)
  - 6) Set your flaps to 20 degrees (2 notches on the wing).

# PART III: TAKEOFF

- 7) Set your prop pitch mode to AUTO. If you set it to MANUAL, put the prop pitch needle in the 12:00 position.
- 8) Lock your tailwheel once lined up on the runway (LShift+G by default)
- 9) Throttle up to full power. Correct heading with small rudder input.
- 10) As soon as you reach 120 kph, center the stick and level out to pick some speed.
- 11) When you reach 180 kph, rotate gently.
- 12) Once you are up in the air, retract flaps, pull your gear up and start climbing. Adjust manifold pressure accordingly (see engine management in part V).

# PART IV: LANDING

- 1) Deploy landing gear when going slower than 350 kph.
- 2) Deploy flaps 20 degrees when going slower than 250 kph.
- 3) Set your prop pitch to AUTO or set the needle at 11:30 in MANUAL mode. Throttle as required to maintain approach speed at 180 kph. Recommended engine setting is 1500 RPM @ 0.6 ATA.
- 4) Trim nose down as flaps generate extra lift.
- 5) Cut throttle when reaching runway and start a gentle, but firm flare.
- 6) Touchdown at 160 kph.
- 7) Once on the ground, pull back on the stick to lock your tailwheel and tap your brakes.



# Powerplant

- The Bf.109 G-2 is powered by the **Daimler-Benz DB 605 A1**, a liquid-cooled inverted V-12 engine. The DB 601A-1 engine was a development of the DB 601E engine utilised by the preceding Bf 109 F-4; displacement and compression ratio were increased as well as other detail improvements to ease large-scale mass production.
- The DB 605 suffered from reliability problems during the first year of operation, and this output was initially banned by VT-Anw.Nr.2206, forcing *Luftwaffe* units to limit maximum power output to 1,310 PS (1,292 hp, 964 kW) at 2,600 rpm and 1.3 atm manifold pressure (38.9 inches/4.4 lbs). The full output was not reinstated until 8 June 1943 when Daimler-Benz issued a technical directive.

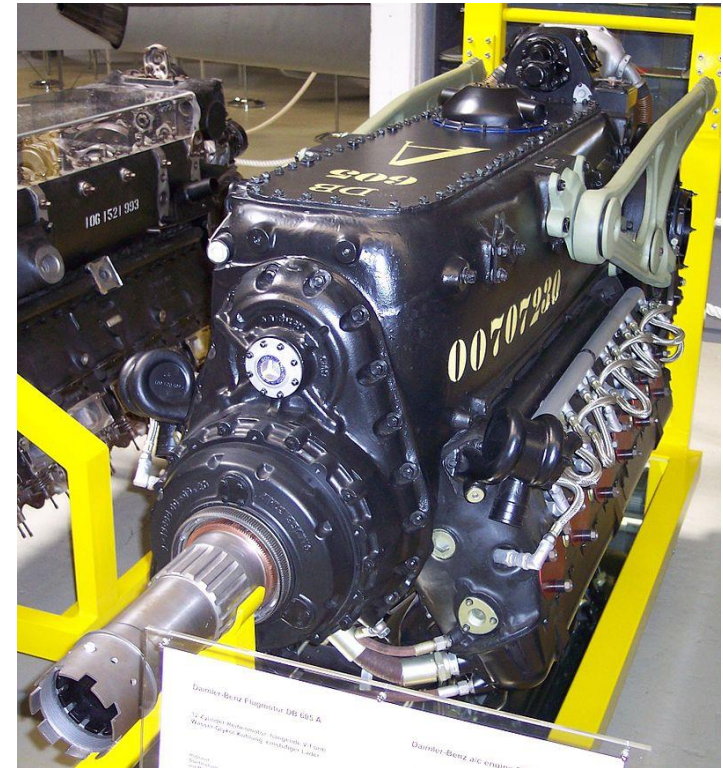



# Operating Limits

- Min coolant temperature: 40 deg C.
- Max coolant temperature: 100 deg
- Min oil temperature: 40 deg C.
- Max oil temperature: 80 deg C.

COOLANT EXIT TEMPERATURE (DEG C)



OIL INTAKE TEMPERATURE (DEG C)

# Recommended Settings

- Takeoff
  - 2500 RPM, 1.3 ATA
- Climb
  - 2500 RPM, 1.3 ATA, speed 250-350 kph
- Normal Operation (Cruise)
  - 1900 RPM, 1.0 ATA
- Combat
  - 2500 RPM, 1.3 ATA
- Landing
  - 1500 RPM, 0.6 ATA



## PART VI: AIRCRAFT PERFORMANCE

- Range: 880 km
- Fuel Max Capacity: ~400L
- Endurance: 105 min (1h45)
- Operational ceiling: 12000 m
- Optimal Climb Speed: 280 kph
- Best Climb Rate: 1140 m/min
- Turn time: 20-21 s
- Note: Your fuel loadout will impact your aircraft's performance, but also your weapon loadout. Performance data often being subject to many factors (test conditions, state of aircraft (captured vs factory fresh), etc.), these numbers are to be taken with a grain of salt. Just like today, aircraft performance can and will vary between the real values and the values that you get on paper.



## PART VI: AIRCRAFT PERFORMANCE

- Addition of slats helps slow speed handling, but will not help you turn better at higher speeds.
- Given enough speed, the Bf 109 will outclimb anything the Russians send at you. Use it to your advantage.
- Turn performance is decent, but very risky. Competent Yak-1 pilots WILL out-turn you if you fight in the horizontal plane. Stay vertical and use the sun as cover.
- Be smooth when pulling the stick: you will maintain airspeed.
- Bf.109 is an aerodynamic marvel of engineering, but it can bleed airspeed if you try to play the Yaks' "turn n' burn" game. Stay high, stay fast. You should fly it like a high-speed energy fighter and use boom and zoom tactics.
- The 109 is very fragile: take that into consideration when you think about going head-on with an Il-2 Sturmovik and its Hun-hungry 37 mm cannons.
- Bf.109 G-2 has more power than the F-4, but in 1942 it still has the 1.3 ATA boost limitation (which the F-4 doesn't have). G-2 is heavier, but better suited for pure boom and zoom. The F-4 is slightly more agile in that regard, which allows a pilot a bit more versatility.
- The G-2 is more of a high-altitude fighter than the F-4. Try to lure VVS fighters at higher altitudes (6000/7000 meters or more) and you will have the advantage.

# PART VI: AIRCRAFT PERFORMANCE

## MAXIMUM SPEED QMB CONDITIONS (Graph by Matt)

